

R-HP803xx 3W Rectangular Power LED Series

Features

Highest Flux

Very long operating life >>50000hr

More Energy Efficient than Incandescent and most Halogen lamps

Low voltage DC operated

Instant light (less than 100 ns)

Superior ESD protection



Package Dimensions

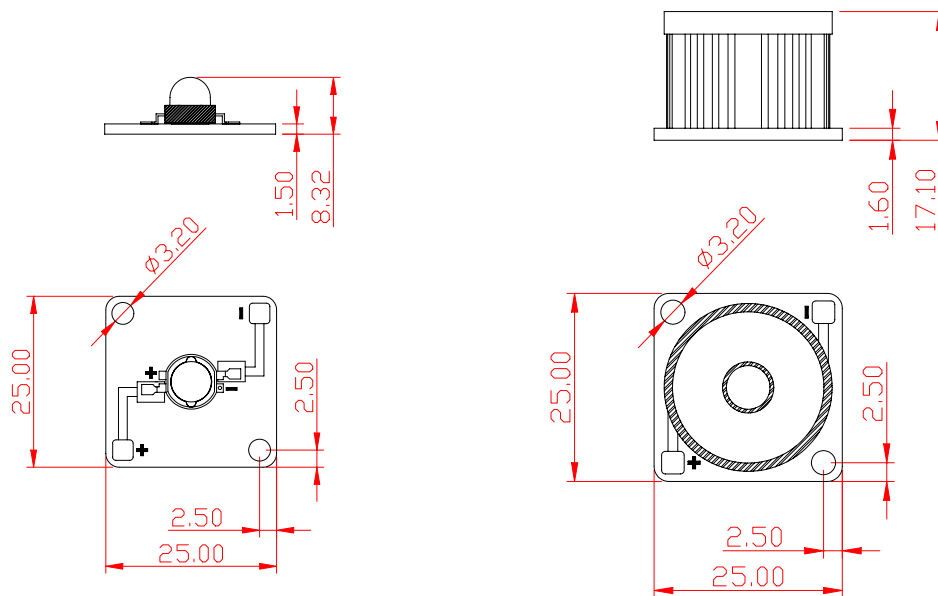

Option : Collimator Lens with 15 degree

Notes

1. Drawings not to scale
2. All dimensions are in millimeters .
3. Tolerance is ± 0.1 mm unless otherwise noted.
4. Protruded resin under flange is 1.0mm max.
5. Lead spacing is measured where the leads emerge from the package.
6. Specifications are subject to change without notice.
7. Precautions for ESD:
STATIC SHIELD Electricity and surge damages the LED. It is recommended to use a wrist band or anti-electrostatic glove when handling the LED. All devices, equipment and machinery must be properly grounded

Absolute Maximum Ratings at Ta=25C

Parameter	Symbol	Max	Unit
Power Dissipation	PD	3	W
Pulse Forward Current	IPF	1000	mA
Forward Current	IF	700	mA
Reverse Voltage	VR	5	V
Operating Temperature Range	Topr	- 40 to +85	C
Storage Temperature Range	Tstg	- 40 to + 85	C

Flux Characteristics at 700mA , Junction Temperature, TJ= 25C

Color	Model	Typ.(Lumens)	Viewing angle
White	R-HP803NW	55 lm	120
Warm White	R-HP803WW	45 lm	120
Blue	R-HP803NB	16 lm	120
Cyan	R-HP803CN	40 lm	120
Pure Green	R-HP803PG	55 lm	120
Amber	R-HP803NO	36 lm	120
Red	R-HP803NR	40 lm	120

Optical Characteristics at 700mA , Junction Temperature, TJ = 25C

Color	CCT / λD			Λ	λ/T
	Min.	Typ.	Max.		
White	5000K	6000K	7000K	--	--
Warm White	2850K	3300K	3800K	--	--
Blue	460nm	470nm	475nm	25	0.04
Cyan	490nm	505nm	515nm	30	0.04
Pure Green	515nm	525nm	540nm	35	0.04
Amber	587nm	590nm	595nm	20	0.05
Red	620nm	630nm	645nm	20	0.05

Electrical Characteristics at 700mA , Junction Temperature, T_J = 25C

Color	Forward Voltage			/W	V/T
	Min.	Typ.	Max.		
White	3.8 v	4.0 v	4.2 v	15	-2.0
Warm White	3.8 v	4.0 v	4.2 v	15	-2.0
Blue	3.8 v	4.0 v	4.2 v	15	-2.0
Cyan	3.8 v	3.8 v	4.2 v	15	-2.0
Pure Green	3.8 v	3.8 v	4.2 v	15	-2.0
Amber	2.8 v	3.0 v	3.2 v	18	-2.0
Red	2.8 v	3.0 v	3.2 v	18	-2.0

Notes

1. Minimum luminous flux or radiometric power performance guaranteed within published operating conditions. maintains a tolerance of $\pm 10\%$ on flux and power measurements
2. Dominant wavelength is derived from the CIE 1931 Chromaticity diagram and represents the perceived color. maintains a tolerance of ± 1 nm for dominant wavelength measurements.
3. CCT $\pm 5\%$ tester tolerance.

Precautions For Use

- Over-current-proof

Customer must apply resistors for protection, otherwise slight voltage shift will cause big current change Burn out will happen

Typical Electrical / Optical Characteristics Curves

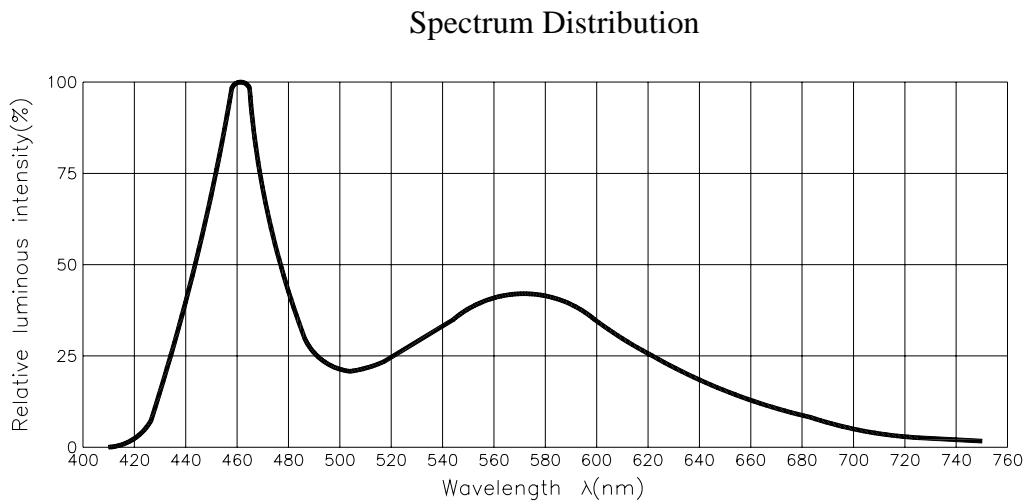
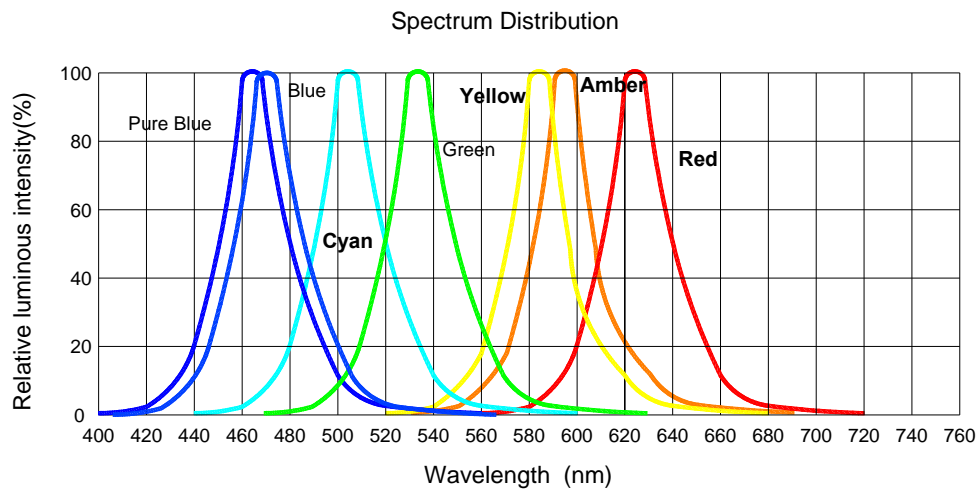

Forward Current VS. Forward Voltage

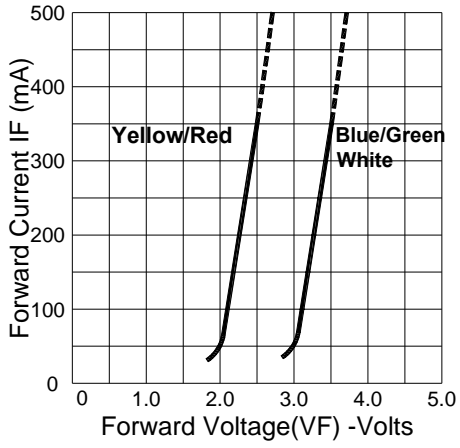

Luminous Intensity VS. Forward Current

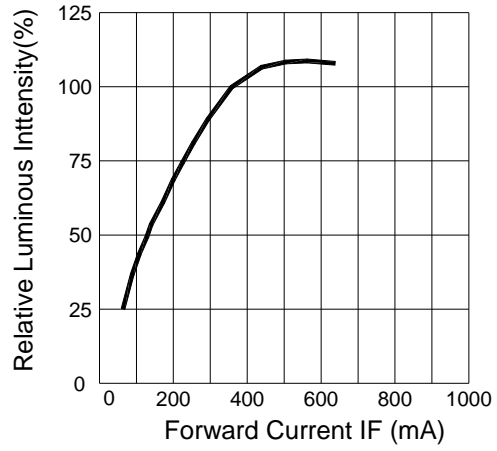

Forward Current VS. Ambient Temperature

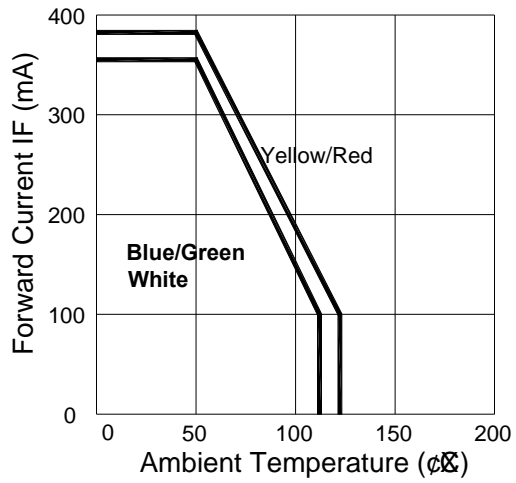

Radiation Diagram

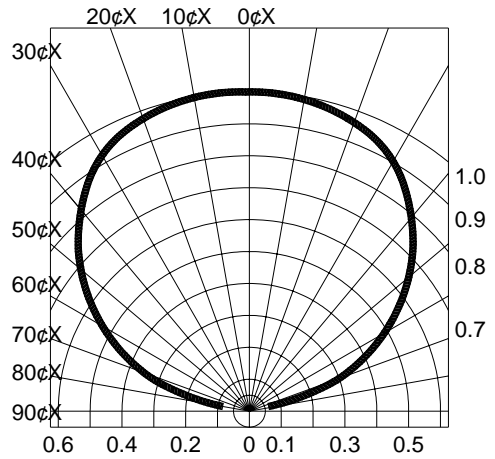

Reliability Test Items and Conditions

No.	Item	Test Conditions	Test time	Ac/Re			
1	Solder Heat	260±5C	5 sec	0/1			
2	Temperature Cycle	-40C	25C	105C	25C	100cycle	0/1
		30 min	5 min	30 min	5 min		
3	Thermal Shock	-40C	105C	20 cycle	0/1		
		5 min	5 min				
4	High Temperature Storage	85C	1000 hrs	0/1			
5	Low Temperature Storage	-35C	1000 hrs	0/1			
6	DC Operating Life	I _F □ 350mA	1000 hrs	0/1			
7	High Temperature/High Humidity	Ta 60C □ R.H 90 □.	1000 hrs	0/1			
Judgment Criteria		Forward Voltage V _f	V _{f max} Increase <1.2x				
		Reverse Current I _R	I _{R max} Increase <2x				
		Luminous Intensity Flux	I _v Decay < 50%				

Note □ Measurement shall be taken after the tested samples have been returned to normal ambient conditions .

Soldering heat reliability □ DIP □ Please refer to the following figure

